

Interlock Armored Cable

Application Guide

Superior Essex manufactures a wide variety of cable and wire designs and configurations. This document provides installation preparation recommendations for various configurations of Interlock Armored Premises Fiber, OSP Fiber, Premises Copper and Coax cables. While this application guide addresses standard interlock armored cable offerings, custom configurations are offered as well. Installation personnel should be familiar with applicable codes or established practices for their locale.



Product Description





Interlock Armored cables provide for an extremely well protected cable package, offering additional mechanical protection. Various cable options allow system designers products that can be installed in high traffic areas where added mechanical protection and security are required. Interlock armored cabling is also advantageous for retrofit applications and may eliminate the need to install rigid conduit while still meeting building code guidelines. The following cable types are available with interlock armoring: **Premises Optical Fiber, OSP Optical Fiber, Premises Copper** and **Coax**. Premises copper (CAT 6, CAT 5e, CAT 3 and RG6 Quad Coax type) are CMR (riser) rated while optical fiber cable may be ordered with OFCR (riser) or OFCP (plenum) ratings. Interlock armored cables with two copper components of the same type may be ordered with either different colored components or uniquely labeled components. The interlock armored option is also available in aluminum or steel and the final cable assembly may be ordered with bare metal or with an exterior jacket. Each cable component is tested after interlock armoring to ensure that all applicable industry requirements are met. Additionally, Superior Essex can offer interlock armored cables in custom configurations to meet a range of customer applications.







Applications

- Intrabuilding backbones
- Conduit pathways
- Service entrance to communication closets
- Deployments that demand increased mechanical protection

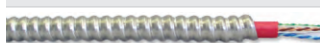
Features	Benefits
Thick, flexible metallic armor	» Reduced incidences of circuit disruption due to rodents or mechanically abusive applications
Flame Retardant, UL Listed designs	» Eliminates the need for multiple cable types for installation
Full line of Superior Essex cables available	» Customized designs reduce cable inventory requirements » Installs faster and easier than EMT conduit and conventional wire

Standard Products

Description	Listing	Fiber Count	Standard Configuration	Certifications
Interlock Armored Premises Fiber Cables				
	Single Unit Tight Buffer	OFCR	2 – 24	Riser-rated PVC outer jacket
		OFCP	2 – 24	Low smoke (LS) PVC outer jacket
	Multi-Unit Tight Buffer	OFCR	18 – 144	Riser-rated PVC outer jacket
		OFCP	18 – 72	LS PVC outer jacket
	Single Unit Indoor/Outdoor Tight Buffer	OFCR	2 – 12	Black, riser-rated PVC outer jacket
		OFCP	2 – 12	Black, LS PVC outer jacket
	Multi-Unit Indoor/Outdoor Tight Buffer	OFCR	18 – 144	Black, riser-rated PVC outer jacket
		OFCP	18 – 72	Black, LS PVC outer jacket
Interlock Armored OSP Fiber Cables				
	Single Unit Indoor/Outdoor Loose Tube	OFCR	6 – 144	Black, riser-rated PVC outer jacket
				» UL 1569 » UL, c(UL) Listed OFCR (UL 1666) » Telcordia GR-20 CORE, Issue 2 » RoHS-compliant

Description	Listing	Pair Count	Std. Configuration	Certifications
Interlock Armored Premises Copper Cables				
	CAT 6 Single Component	CMR	4-Pair	No outer jacket
	CAT 6 Dual Component	CMR	2 x 4-Pair	No outer jacket
	CAT 5e Single Component	CMR	4-Pair	No outer jacket
	CAT 5e Dual Component	CMR	2 x 4-Pair	No outer jacket
	CAT 3	CMR	25-Pair	No outer jacket
Interlock Armored Coaxial Cables				
	Coax Series 6 Quad Shield	CMR	N/A	No outer jacket
				» UL 1569 » UL 444 » CSA C22.2 No. 214-08 » UL, c(UL) Listed CM (UL 1685)/ » UL, c(UL) Listed CMR (UL 1666) » RoHS-compliant

Specifications

Product	Listing	Fiber Count (Single or Multimode)	Nominal Diameter in (mm)	Minimum Bend Radius	
				Install in (mm)	Long Term in (mm)
Interlock Armored Premises Fiber Cables					
Single Unit Tight Buffer	OFCR	2, 4, 6, 8	0.54 (13.8)	8.2 (207)	5.4 (138)
		12	0.62 (15.7)	9.3 (236)	6.2 (157)
		18	0.66 (16.8)	9.9 (251)	6.6 (168)
	OFCP	24	0.70 (17.8)	10.5 (267)	7.0 (178)
		2, 4, 6, 8	0.50 (12.7)	7.5 (191)	5.0 (127)
		12	0.55 (13.9)	8.3 (209)	5.5 (139)
Multi-Unit Tight Buffer	OFCR	18, 24	0.59 (15.1)	8.9 (227)	5.9 (151)
		18, 24	0.95 (24.1)	14.2 (362)	9.5 (241)
		36, 48	1.05 (26.8)	15.7 (401)	10.5 (268)
		72	1.23 (31.2)	18.4 (468)	12.3 (312)
		96	1.38 (35.1)	20.7 (527)	13.8 (351)
	OFCP	144	1.48 (37.6)	22.2 (564)	14.8 (376)
		18	0.85 (21.7)	12.8 (325)	8.5 (217)
		24	0.90 (22.8)	13.5 (343)	9.0 (228)
		36, 48	1.02 (25.8)	15.2 (387)	10.2 (258)
		72	1.19 (30.3)	17.9 (455)	11.9 (303)
Single Unit Indoor/Outdoor Tight Buffer	OFCR	2, 4, 6, 8	0.54 (13.8)	8.2 (207)	5.4 (138)
		12	0.62 (15.7)	9.3 (236)	6.2 (157)
	OFCP	2, 4, 6, 8	0.50 (12.7)	7.5 (191)	5.0 (127)
		12	0.55 (13.9)	8.2 (209)	5.5 (139)
Multi-Unit Indoor/Outdoor Tight Buffer	OFCR	18, 24	0.95 (24.1)	14.2 (362)	9.5 (241)
		36, 48	1.05 (26.8)	15.8 (401)	10.5 (268)
		72	1.23 (31.2)	18.4 (468)	12.3 (312)
		96	1.38 (35.1)	20.7 (527)	13.8 (351)
		144	1.48 (37.6)	22.2 (564)	14.8 (376)
	OFCP	18	0.85 (21.7)	12.8 (325)	8.5 (217)
		24	0.90 (22.8)	13.5 (343)	9.0 (228)
		36, 48	1.02 (25.8)	15.2 (387)	10.2 (258)
		72	1.19 (30.3)	17.9 (455)	11.9 (303)
		Interlock Armored OSP Fiber Cables			
Single Unit Indoor/Outdoor Loose Tube	OFCR	6, 12, 24, 48	0.96 (24.3)	14.5 (367)	9.6 (243)
		72	1.01 (25.5)	15.2 (383)	10.1 (255)
		96	1.07 (27.1)	16.1 (406)	10.7 (271)
		144	1.20 (30.8)	18.3 (463)	12.2 (308)

Product	Number of Components	Copper Pair Count	Nominal Diameter in (mm)	Bend Radius in (mm)
Interlock Armored Premises Copper Cables				
CAT 6	1	4-Pair	0.49 (12.5)	6.86 (174.2)
	2	2 x 4-Pair	0.80 (20.2)	11.20 (284.5)
CAT 6 with Outer Jacket	1	4-Pair	0.55 (14.0)	7.70 (195.6)
	2	2 x 4-Pair	0.87 (22.2)	12.18 (309.4)
CAT 5e	1	4-Pair	0.44 (11.1)	6.16 (156.5)
	2	2 x 4-Pair	0.80 (20.2)	11.20 (284.5)
CAT 5e with Outer Jacket	1	4-Pair	0.50 (12.6)	7.00 (177.8)
	2	2 x 4-Pair	0.88 (22.2)	12.32 (312.9)
CAT 3	1	25-Pair	0.79 (20.2)	11.06 (280.9)
Interlock Armored Coaxial Cables				
Coax Series 6 Quad Shield	1	N/A	0.53 (13.5)	6.86 (174.2)

Cable Temperature Guidelines¹

Cable Type	Series	Listing	Operation	Storage/ Shipping	Installation ²
Premises Single Unit Distribution Fiber (Tight Buffer)	33, 43	CMR	-40 to 70°C (-40 to 158°F)	-40 to 70°C (-40 to 158°F)	-20 to 60°C (-4 to 140°F)
	34, 44	CMP	0 to 70°C (32 to 158°F)	-40 to 70°C (-40 to 158°F)	0 to 60°C (32 to 140°F)
Premises Multi-Unit Distribution Fiber (Tight Buffer)	43	CMR	-20 to 70°C (-4 to 158°F)	-40 to 70°C (-40 to 158°F)	0 to 60°C (32 to 140°F)
	44	CMP	0 to 70°C (32 to 158°F)	-40 to 70°C (-40 to 158°F)	0 to 60°C (32 to 140°F)
Indoor/Outdoor Sunlight Resistant Distribution Fiber (Tight Buffer)	24	CMP	-20 to 70°C (-4 to 158°F)	-40 to 70°C (-40 to 158°F)	-20 to 60°C (-4 to 140°F)
Dry Block/Sunlight Resistant Indoor/Outdoor Distribution Fiber (Tight Buffer)	W3	CMR	-40 to 70°C (-40 to 158°F)	-40 to 70°C (-40 to 158°F)	-20 to 60°C (-4 to 140°F)
	W4	CMP	-40 to 70°C (-40 to 158°F)	-40 to 70°C (-40 to 158°F)	-10 to 60°C (6.8 to 140°F)
OSP Fiber (Loose Tube)	All	N/A	-40 to 70°C (-40 to 158°F)	-40 to 70°C (-40 to 158°F)	-30 to 60°C (-22 to 140°F)
Premises Copper	All	CMR	-20 to 60°C (-4 to 140°F)	-40 to 75°C (-40 to 158°F)	0 to 60°C (32 to 140°F)
		CMP	-20 to 60°C (-4 to 140°F)	-40 to 75°C (-40 to 158°F)	0 to 60°C (32 to 140°F)

¹ These temperature guidelines are applicable to traditional cable designs manufactured to industry standards. These guidelines are provided for convenience purposes only and do not replace or overrule individual cable performance specifications.

² Cables stored/shipped at temperatures outside the allowable installation temperature range must be conditioned prior to installation by storing for 24 hours within the allowable installation temperature range. For best results and ease of installation in freezing temperatures, condition the cable for 24 hours at or above 18°C (65°F) prior to installation.

Recommended Installation Tools

- Diagonal cutters (oblique pliers)
- Splicer's knife or splicer's/electrician's snips (5" scissors)
- Needle-nose pliers (optional)
- Cable cutters
- Interlock armored splitting tool or tube cutter
- Phillips and slotted screw drivers
- Tape measure
- 216C tool (7/16" 3/8" can/terminal wrench)

Armor Removal Tool Options

The design of interlock armored cable requires the use of various types of installation tools. The following table lists available tools that simplify preparation of interlock armored cables. Superior Essex recommends the use of an armor splitting (ROTO-SPLIT) tool to insure cable components are not damaged when removing interlock armor. If a tube cutter is used, caution should be exercised to avoid damage to the cable while making the circular cut.

Manufacturer	Product	Use	Cable Diameter Range (in)	Part Number
Seatek Co. Inc.	ROTO-FLEX™	Armor Splitting	0.75 to 1.125	RF-120A
		Armor Splitting	0.84 to 1.82	RF-170
	ROTO-SPLIT®	Armor Splitting	0.40 to 0.74	RS-101B
Sears Craftsman (or equivalent)	Ratcheting Metallic Tube Cutter	Armor Cutting	0.12 to 1.10	51672

NOTE: Manufacturers' installation recommendations should be followed. This list is believed accurate at time of publication and is provided for convenience purposes only. Always check product compatibility.

Planning

There are factors that will affect interlock armored cable performance that must be respected during installation. While the interlock armored feature provides distinct advantages in both copper and optical fiber cables, certain cable limitations are affected by the addition of the interlock armoring. These limitations vary among cable types, sizes, and even manufacturers. It is essential the designer and installer become familiar with specific technical guidelines prior to installation start. At a minimum, the following parameters should be considered:

Pulling Tension

Always refer to cable specific maximum tensile loading rating prior to installing any interlock armored cable. The maximum pulling tension is 150 pounds based on interlock armor strength. However, the interlock armoring and cable component should be attached together to avoid separation during pulling. In applications where more than 150 pounds of pulling tension is required, the pulling attachment should be secured to the component cable's tensile strength elements in addition to the interlock armored component.

Vertical Runs

Additional measures must be made to support interlock armored cables in vertical runs. Installation of a slack coil in the cable every 50 to 65 feet (15 to 20 meters) is recommended to couple interlock armored cable components in vertical installations.

Vertical and horizontal runs should be supported at regular intervals to maintain desired routing and stability.

Bend Radius

Do not exceed the minimum bend radius of the cable in the routing plan. The minimum bend radius is based on the outside diameter of the interlock armored component and is listed in the specific cable specifications.

Outdoor Use

When interlock armored cables are deployed in outdoor applications, outer jacketed interlock armored configurations are recommended. Application of outdoor-rated silicone adhesive caulks or other approved sealing materials is recommended to prevent potential water ingress in interlock armored cables.

Bonding/Grounding

Interlock armored cables do not incorporate bonding between the cable and the interlock armoring. Where outside to inside building transitions occur, bonding and grounding of the interlock armor to a suitable bond point should be made. Bonding and grounding should be adhered to per local codes in all interlock armored cable installations.

Preparation and Termination

STEP 1: Determine the length of interlock armor (and exterior jacket if equipped) to be removed and mark the cable at that point.

- » If the cable has an exterior jacket covering the interlock armor, use a splicer's knife to make 2 ring cuts 4 to 8 inches (10 to 20 cm) apart on the jacket.

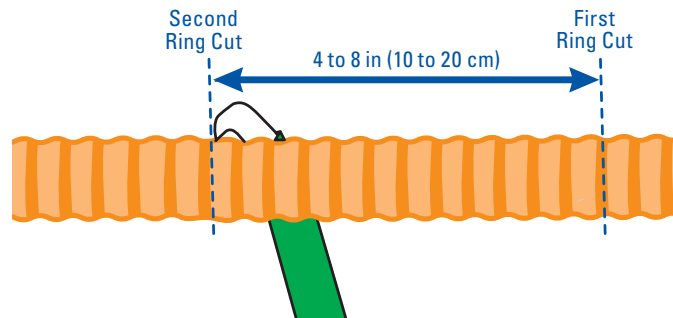

- » Score the jacket laterally between ring cuts and remove outer jacket.

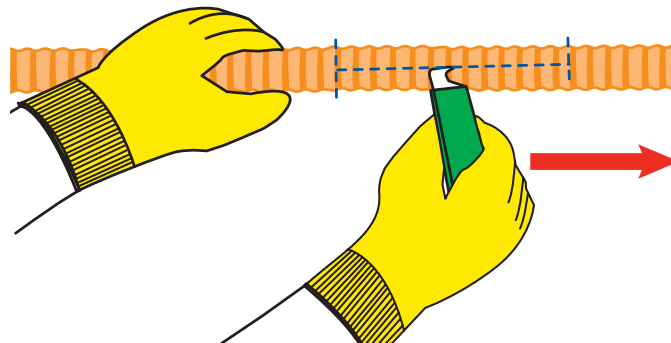

STEP 2: Select appropriate armor split tool for cable diameter.

NOTE: ROTO-SPLIT tool shown for simplicity.

STEP 3: Position cable in armor split tool.

- » Place cable in tool guide and center tool blade over section of armor that is marked.

- » Tighten the tool's adjustable screw between the interlock armor ridges to lock the cable in place.

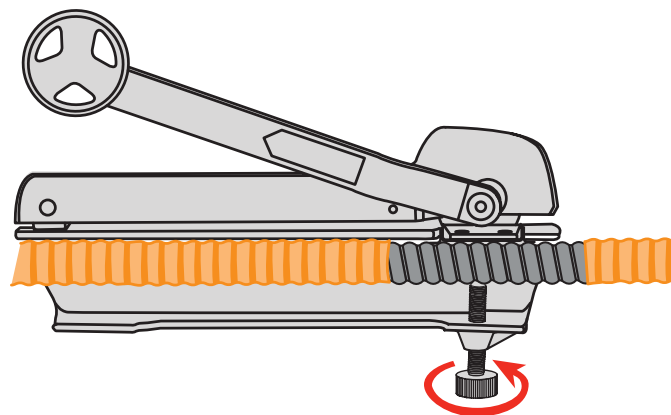

- » Hold the tool behind the cutting head and adjustable screw (or squeeze clamp if tool is equipped with clamp mechanism). Apply pressure until the blade contacts armor.

- » Rotate crank handle while applying slight pressure.

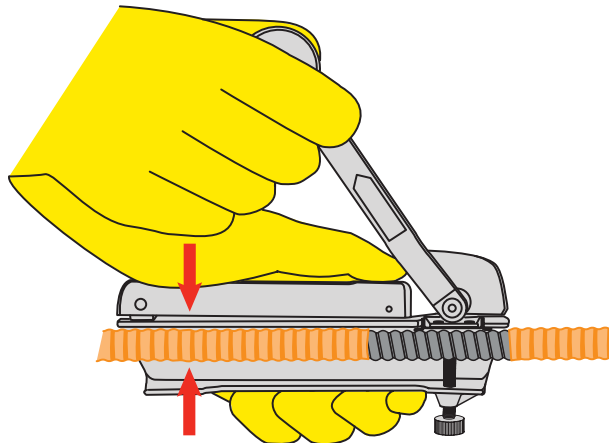

- » When force to turn the crank is suddenly decreased, the armor has been adequately cut.
- » Release screw, remove tool and examine cut.

STEP 4: Remove the cut length of armor from the cable.

- » Hold both sides of the armor cut and twist to separate.

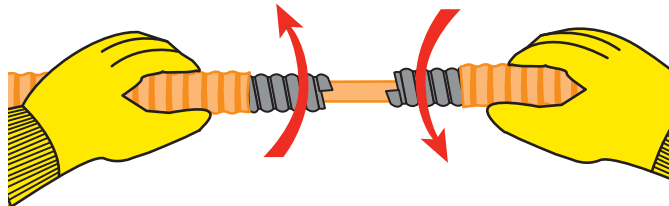

- » Slide off free section of armor to expose cable required for termination and trim any jagged edges of armor.
- » Place small strip of tape under sharp point of armor opening to avoid cutting cable or installation personnel.

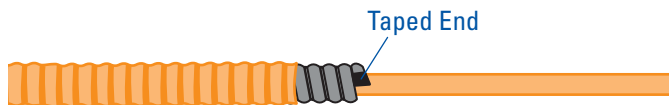

Bonding and Grounding

Interlock armored cable should be bonded on both ends using a #6 AWG, or larger, insulated ground wire. Bonding and grounding is required to insure any voltages or interfering signals are shunted to ground. The metal sheathing of interlock armored cable acts as a ground and should be grounded at all entry and termination points. If an equipment cabinet or panel is used for final termination, NEC approved connectors may be used as the equipment bond for the interlock armored cable. Standard bonding and grounding practices should be followed for the actual cable that is interlock armored.

Third party supplied mechanical bond connectors/clamps are available that do a good job of bonding and grounding the metallic interlock armor to external ground points. Many of these connectors/clamps can be ordered with a ground lead for attachment to the local ground medium at each termination point. Suppliers of these products generally offer good procedural and technical support. Where applicable, local and/or company installation codes and practices should be observed. The following is an example of common bonding/grounding technique.

STEP 1: Determine bond/ground requirements using previous guidelines.

STEP 2: Install bond connectors.

Option A: For bonding/grounding termination points.

- » After the desired lengths of conductors or fibers are exposed, carefully lift the interlock armor shield and position base plate of chosen bond connector between the cable and inside of armor according to bond connector manufacturer's guidelines.

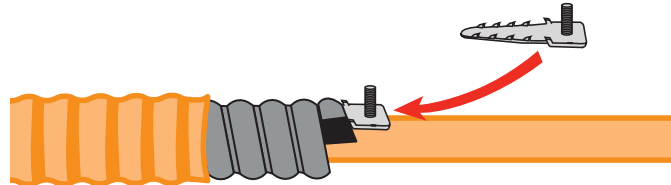

- » Position the top plate of the bond connector to the connector base and tighten.

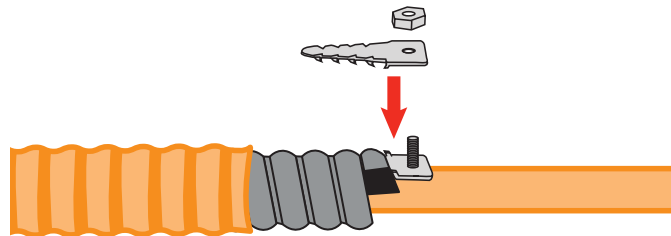

- » Measure and cut ground wire/strap needed to terminate the interlock armor to the ground point.
- » Attach ground wire/strap to bond connector.

- » Cover connector and split armor with tape wrap.

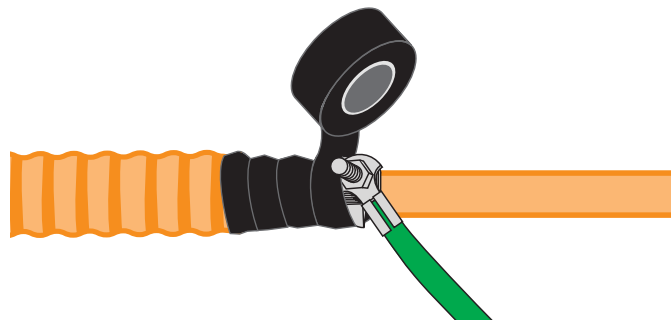

- » Run ground wire/strap to external MGN or suitable ground point at the entry and termination points of the cable run.
- » Insure all ground point nuts are tight at all connections.

Option B: For intermediate and/or bonding/grounding termination points.

- » After the desired lengths of conductors or fibers are exposed, position correctly sized bond clamp around the interlock armor according to bond clamp manufacturer's guidelines.

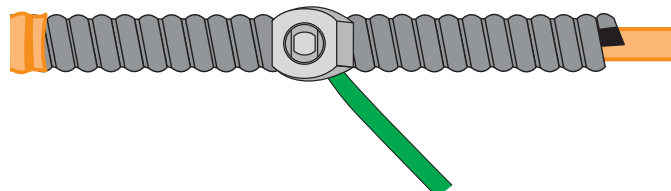

- » Measure and cut ground wire/strap needed to terminate the interlock armor to the ground point.
- » Attach ground wire/strap to bond connector.
- » Run ground wire/strap to external MGN or suitable ground point at the entry and termination points of the cable run.
- » Insure all ground point nuts are tight at all connections.

NOTE: Bond connectors/clamp manufacturers' installation recommendations should be closely followed.

Third Party Bond Connectors/Clamps		
Manufacturer	Description	Part Number
3M	Cable/armor bond connector	4460-S or 4460-FN
	Cable/armor bond connector	EM 20B1, EM 20B2, EM 20B3
Electric Motion Company	Conduit bond clamp	3958- SS
	Conduit bond clamp with 10" bond strap	3958-S1010
American Connectors, Inc.	Interlock armored termination in cabinets/termination panels	Custom per cable size; see AmericanConnectors.com

NOTE: This suggested list is believed accurate at time of publication and is provided for convenience purposes only. Other options exist and may be preferable. Always check product compatibility.

Cable Termination

Cable termination must accommodate bonding of any metallic shields if the cable type includes metallic shields. The core wrap must extend beyond the end of any metallic shields to provide dielectric protection between the shield and cable conductors or optical fibers. The exact length the core conductors/fibers extend beyond metallic foil shields depends on the desired spacing between the shield connection and terminating point or device for that particular installation. Allow for adequate slack so that conductor or fiber termination is easily accommodated.

Remove the remaining non-interlock armored cable jacket and cut the insulated conductors or fibers to the required length for termination. The interlock armored cable is ready for final termination.